



BBQ Catalogue



Barbecue en Brique avec Four pizza et Evier
Brick barbecue kit with oven and sink
Barbacoas de Obra con Horno y Fregadero



Barbecue en Brique avec Four pizza et Evier

Brick barbecue kit with oven and sink

Barbacoas de Obra con Horno y Fregadero



Noir
Dark
Negro



Crème
Cream
Beige



Garantie
Guarantee
Garantia



Grilloir
Grill
Parilla



Évier
Sink
Fregadero



Four
Oven
Horno

AV350B



Dimensões

Características

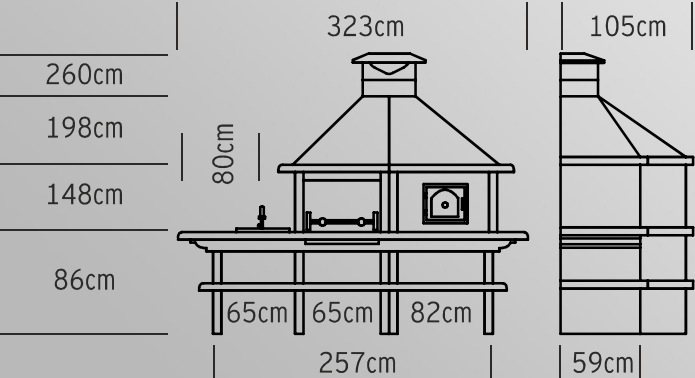

1900 Kg



Garantia



Grelha

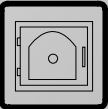

Forno 80

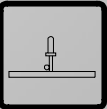

Pio

AV352F



Dimensões

Características

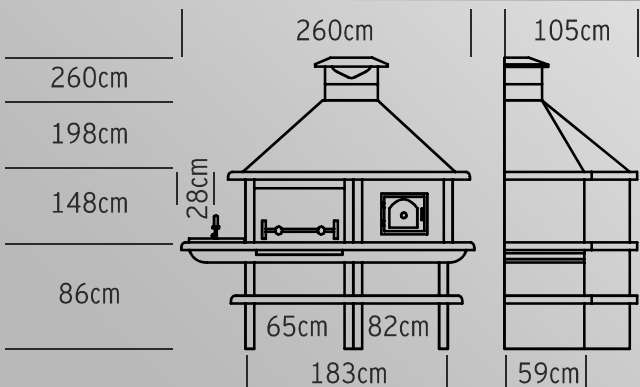

1730 Kg



Garantia

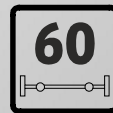

Grelha

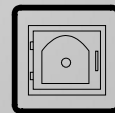

Forno 80

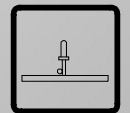

Pio

AV353F



Dimensões

Características

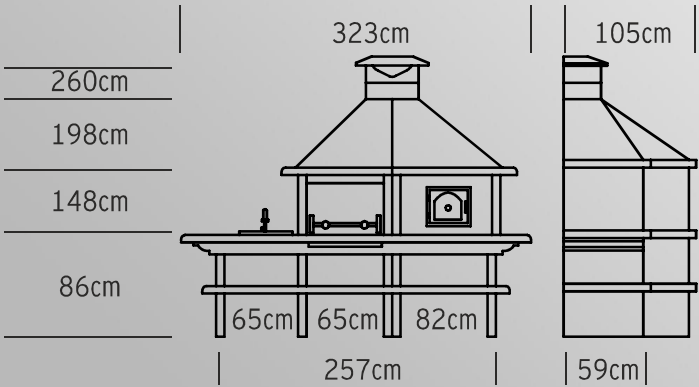

1900 Kg



Garantia



Grelha

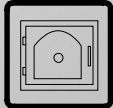

Forno 80

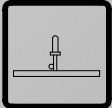

Pio

AV5900F



Dimensões

Características

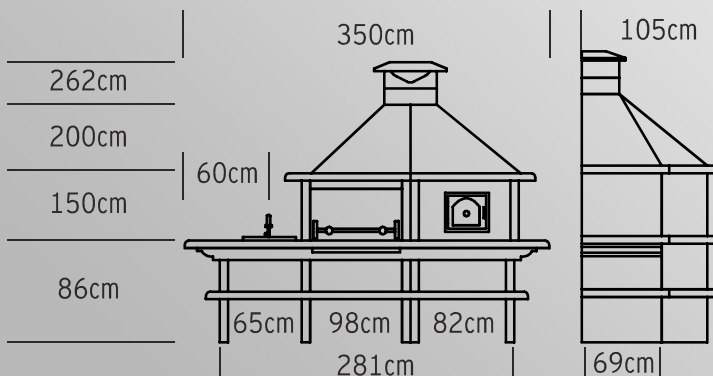

2200 Kg



2 ANOS
Garantia

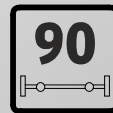

90
Grelha

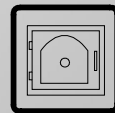

Forno 80

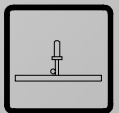

Pivo

Barbecue four a bois et évier | Handmade Barbecue and Oven | Barbacoa de Obra con Horno de Lena

AV357F



Dimensões

Características

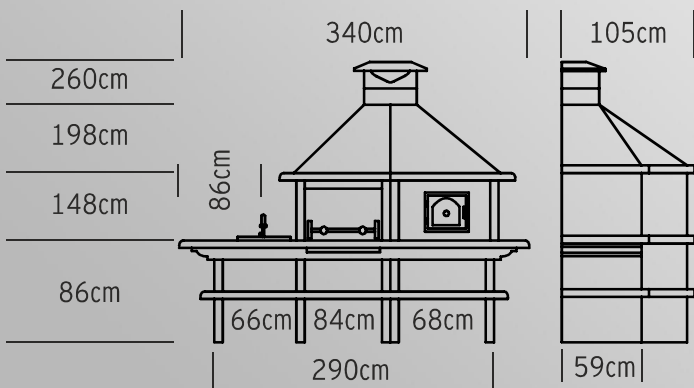

2150 Kg



2 ANOS Garantia



75 Grelha

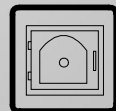

Forno 80

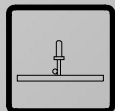

Pio

AV360B



Dimensões

Características

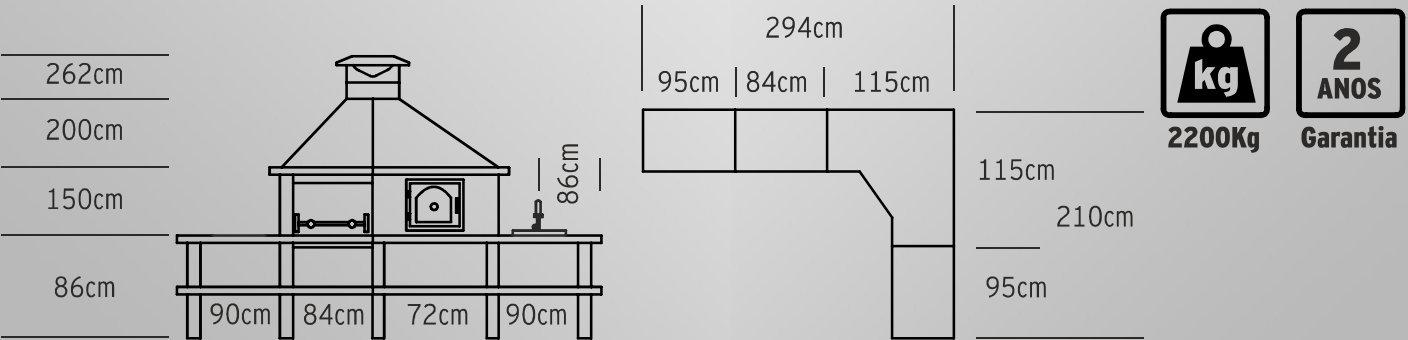

Barbecue d'angle avec Four | Brick Barbecue and Wood Fired Oven | Horno de Lena y Barbacoa de Obra

Four peut être à droite ou gauche du Barbecue



Dimensions

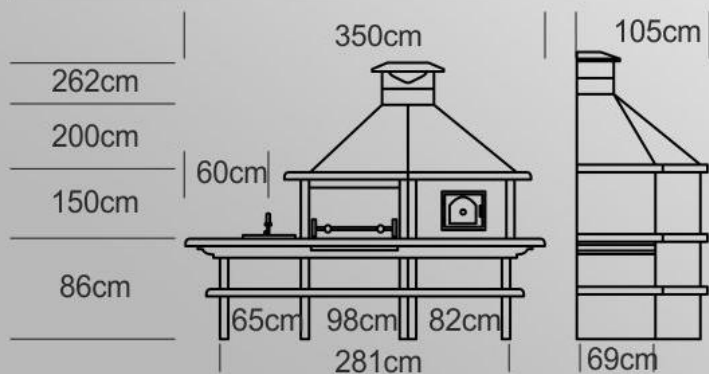

Caractéristiques

- 
2200 Kg
- 
2 ANS Garantie
- 
90 Grilloir
- 
Four 80
- 
Évier

Four peut être à droite ou gauche du Barbecue



Dimensions

Caractéristiques

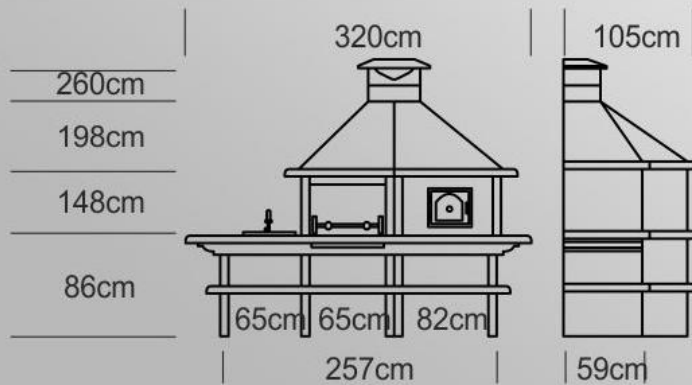

1900 Kg



2 ANS Garantie



60 Grilloir

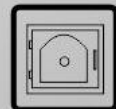

Four 80

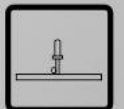

Évier



Dimensions

Caractéristiques

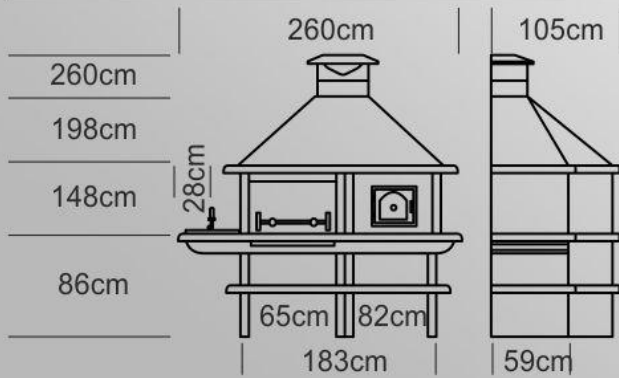

1810 Kg



2 ANS Garantie



60 Grilloir

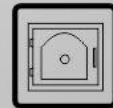

Four 80

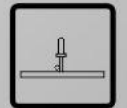

Évier



Dimensions

Caractéristiques

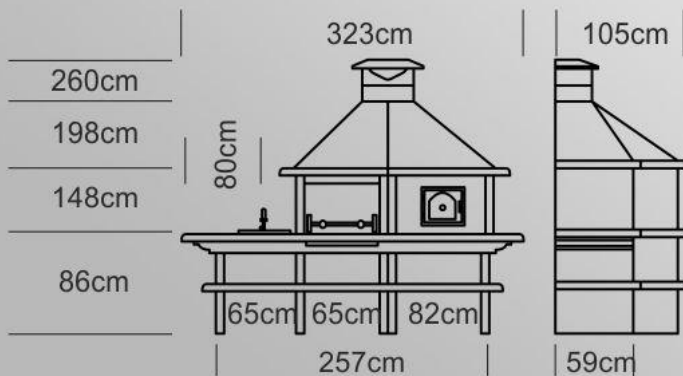

Four peut être à droite ou gauche du Barbecue



Dimensions

Caractéristiques

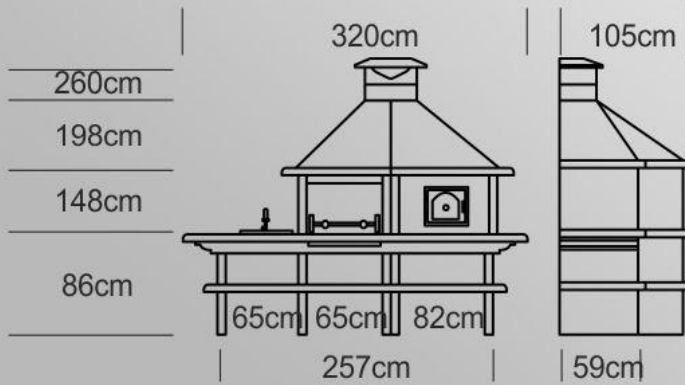

1300 Kg



2 ANS Garantie



60 Grilloir

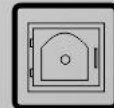

Four 80

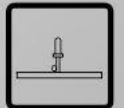

Évier

Four peut être à droite ou gauche du Barbecue



Dimensions

Caractéristiques

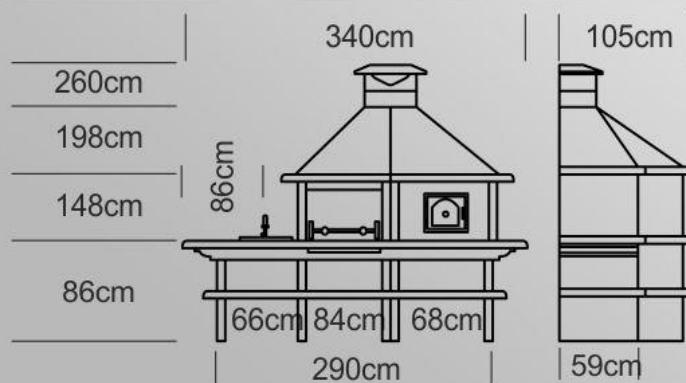

2150 Kg



2 ANS Garantie



75 Grilloir

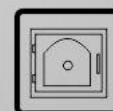

Four 80

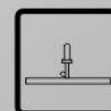

Évier



www.my-barbecue.com

info@my-barbecue.com

